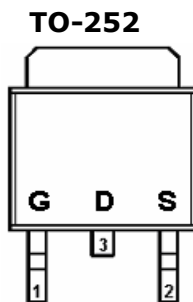
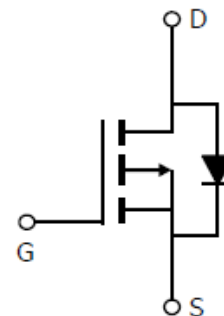
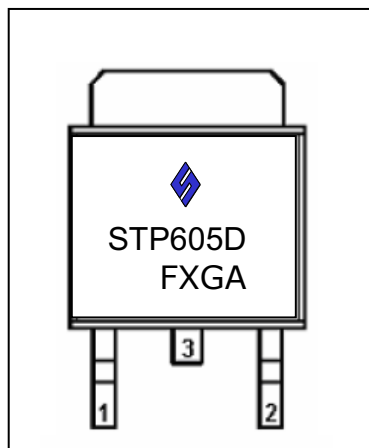

DESCRIPTION

STP605D is the P-Channel logic enhancement mode power field effect transistor which is produced using high cell density, DMOS trench technology. The STP607D has been designed specially to improve the overall efficiency of DC/DC converters using either synchronous or conventional switching PWM controllers. It has been optimized for low gate charge, low $R_{DS(ON)}$ and fast switching speed.

PIN CONFIGURATION (D-PAK)

FEATURE

- -60V/-10.0A, $R_{DS(ON)} = 70m\Omega$ (Typ.)
@ $V_{GS} = -10V$
- -60V/-5.0A, $R_{DS(ON)} = 80m\Omega$ (Typ.)
@ $V_{GS} = -10V$
- Super high density cell design for extremely low $R_{DS(ON)}$
- Exceptional on-resistance and maximum DC current capability
- TO-252package design

PART MARKING

F: Year Code
X: Date Code
Q: Process Code
A: Wafer Code



STP605D



P Channel Enhancement Mode MOSFET

-15.0A

ABSOLUTE MAXIMUM RATINGS (Ta = 25°C Unless otherwise noted)

Parameter	Symbol	Typical	Unit
Drain-Source Voltage	VDSS	-60	V
Gate-Source Voltage	VGSS	±20	V
Continuous Drain Current (TJ=150°C)	ID	-15.0 -7.0	A
Pulsed Drain Current	IDM	-30	A
Continuous Source Current (Diode Conduction)	IS	-15	A
Power Dissipation	PD	25	W
Operation Junction Temperature	TJ	150	°C
Storage Temperature Range	TSTG	-55/150	°C
Thermal Resistance-Junction to Ambient	RθJA	25	°C/W



STP605D



P Channel Enhancement Mode MOSFET

-15.0A

ELECTRICAL CHARACTERISTICS (Ta = 25°C Unless otherwise noted)

Parameter	Symbol	Condition	Min	Typ	Max	Unit
Static						
Drain-Source Breakdown Voltage	$V_{(BR)DSS}$	$V_{GS}=0V, I_D=-250\mu A$	-60			V
Gate Threshold Voltage	$V_{GS(th)}$	$V_{DS}=V_{GS}, I_D=-250\mu A$	-1.5		-3.0	V
Gate Leakage Current	I_{GSS}	$V_{DS}=0V, V_{GS}=\pm 20V$			± 100	nA
Zero Gate Voltage Drain Current	I_{DSS}	$V_{DS}=-48V, V_{GS}=0V$			-1	uA
		$V_{DS}=-48V, V_{GS}=0V$ $T_J=55^\circ C$			-5	
On-State Drain Current	$I_{D(on)}$	$V_{DS} \geq -10V, V_{GS}=-5V$	-10			A
Drain-source On-Resistance	$R_{DS(on)}$	$V_{GS}=-10V, I_D=-10A$		70	80	mΩ
		$V_{GS}=-4.5V, I_D=-5A$		80	100	
Forward Transconductance	g_{fs}	$V_{DS}=-5V, I_D=-10A$	13			S
Diode Forward Voltage	V_{SD}	$I_S=-7.8A, V_{GS}=0V$			-1.0	V
Dynamic						
Total Gate Charge	Q_g	$V_{DS}=-30V, V_{GS}=-10V$ $I_D=-10A$		16		nC
Gate-Source Charge	Q_{gs}			8		
Gate-Drain Charge	Q_{gd}			3.0		
Input Capacitance	C_{iss}	$V_{DS}=-30V, V_{GS}=0V$ $F=1MHz$			1200	pF
Output Capacitance	C_{oss}			115		
Reverse Transfer Capacitance	C_{rss}			7		
Turn-On Time	$t_{d(on)}$	$V_{GS}=-10V, V_{DS}=-30V$ $R_{REGN}=3\Omega, R_L=2.5\Omega$		9		nS
	t_r			10		
Turn-Off Time	$t_{d(off)}$			25		
	t_f			11		

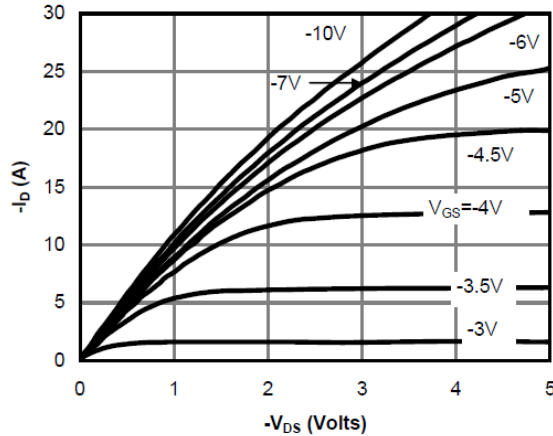
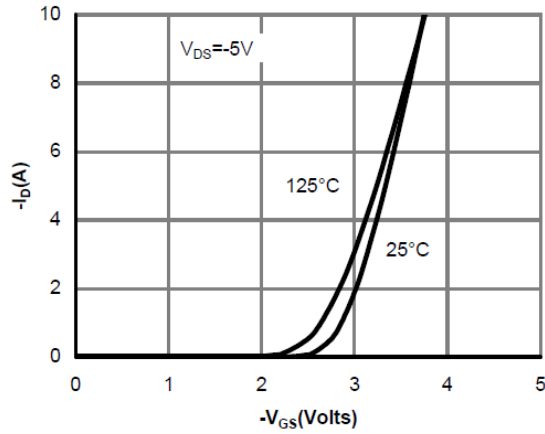
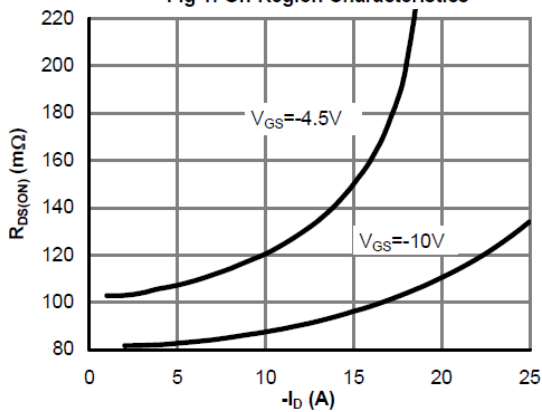
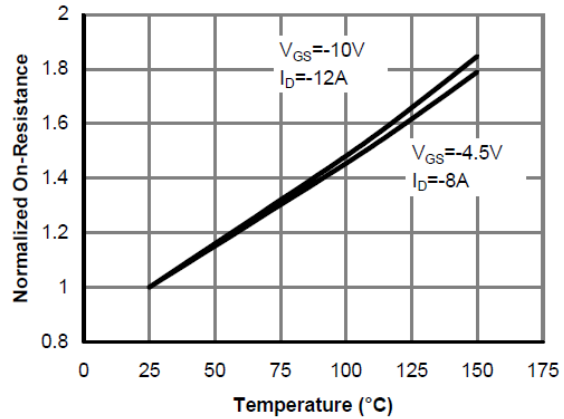
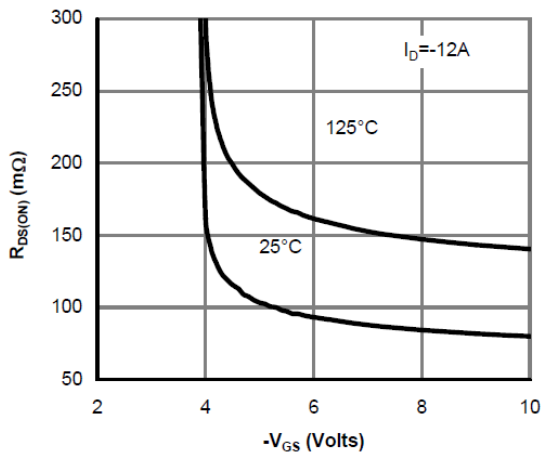
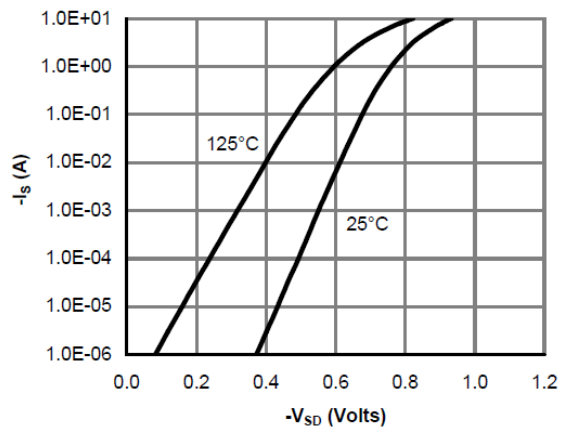
TYPICAL CHARACTERISTICS

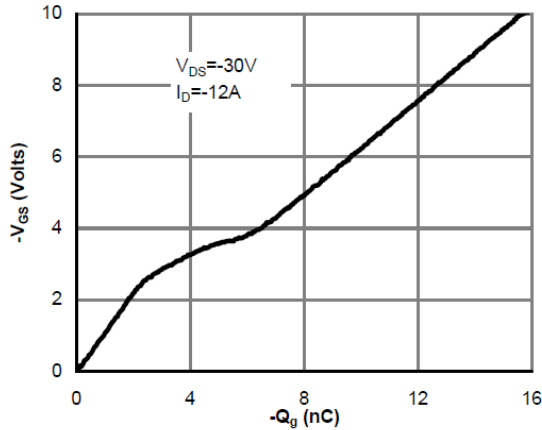
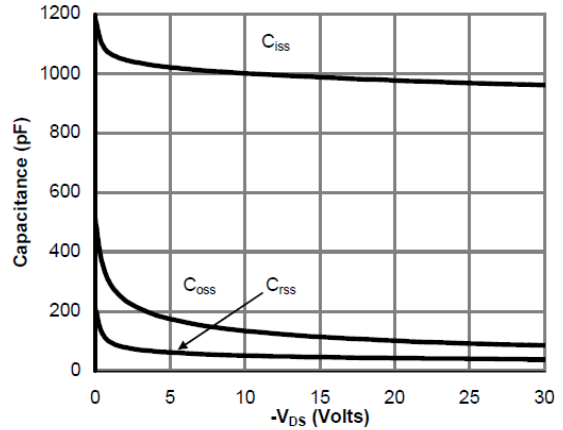
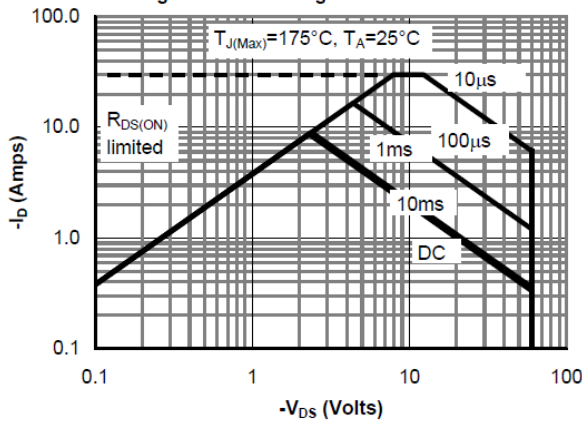
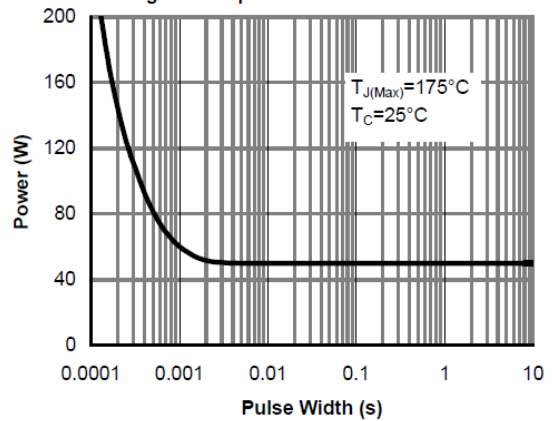
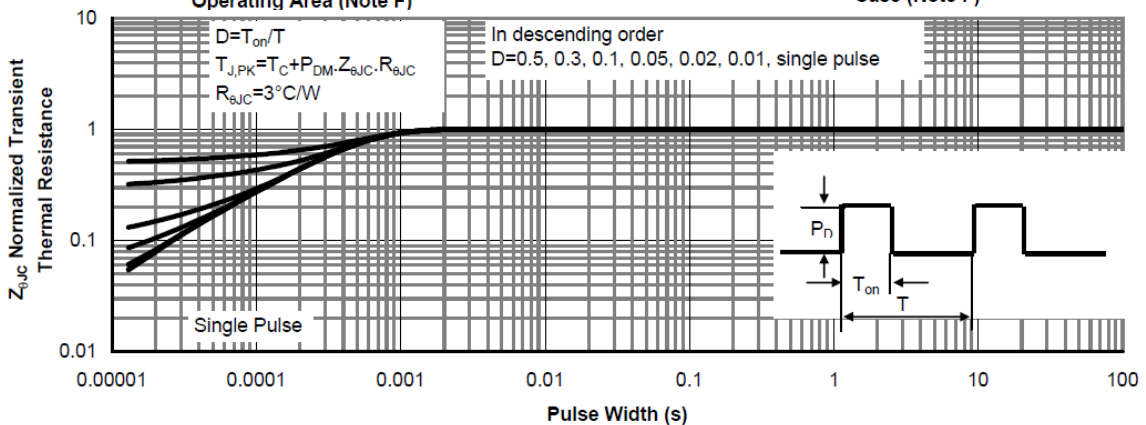
Fig 1: On-Region Characteristics

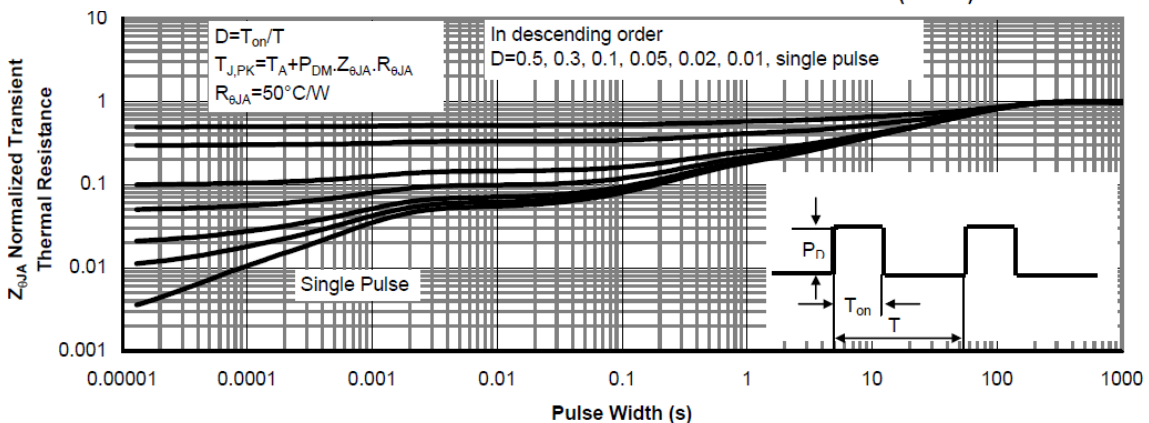
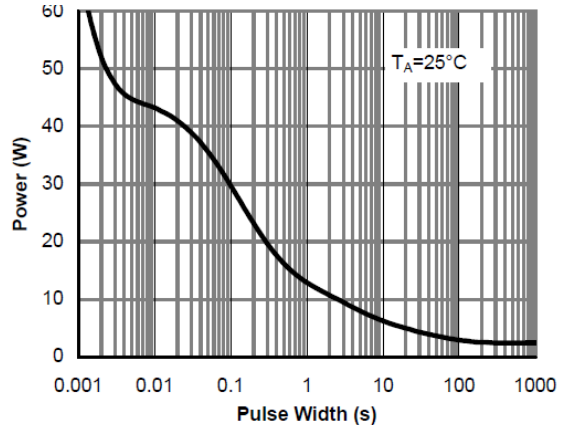
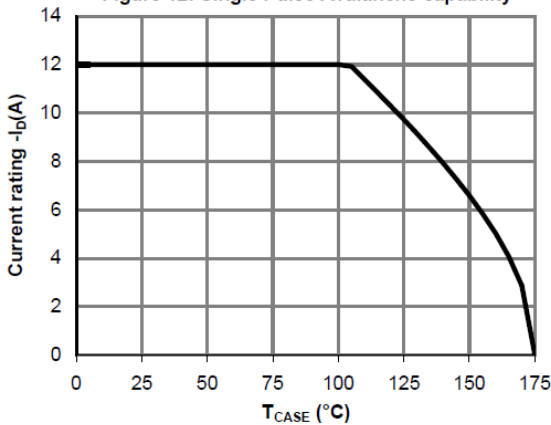
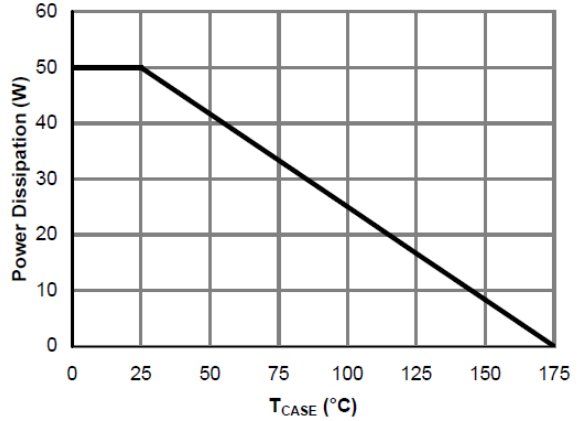
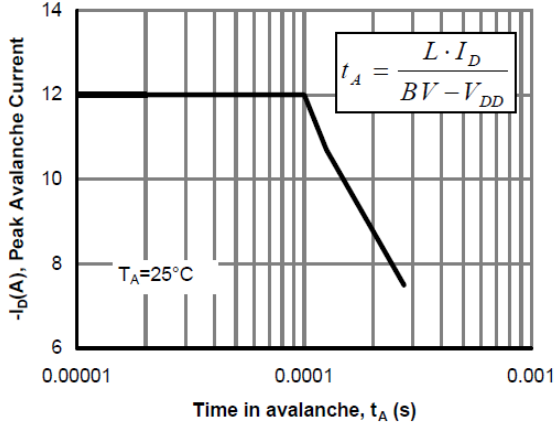
Figure 2: Transfer Characteristics

Figure 3: On-Resistance vs. Drain Current and Gate Voltage

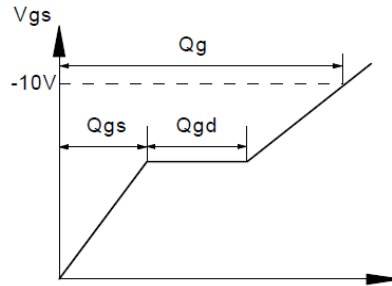
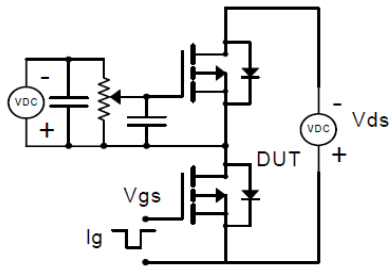
Figure 4: On-Resistance vs. Junction Temperature

Figure 5: On-Resistance vs. Gate-Source Voltage

Figure 6: Body-Diode Characteristics

TYPICAL CHARACTERISTICS

Figure 7: Gate-Charge Characteristics

Figure 8: Capacitance Characteristics

Figure 9: Maximum Forward Biased Safe Operating Area (Note F)

Figure 10: Single Pulse Power Rating Junction-to-Case (Note F)

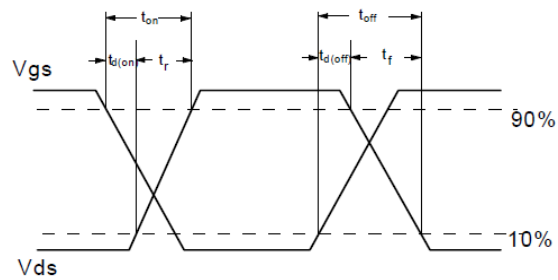
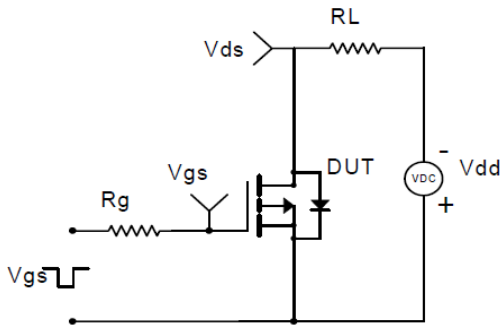
Figure 11: Normalized Maximum Transient Thermal Impedance (Note F)

TYPICAL CHARACTERISTICS

Gate Charge Test Circuit & Waveform



Resistive Switching Test Circuit & Waveforms



Unclamped Inductive Switching (UIS) Test Circuit & Waveforms

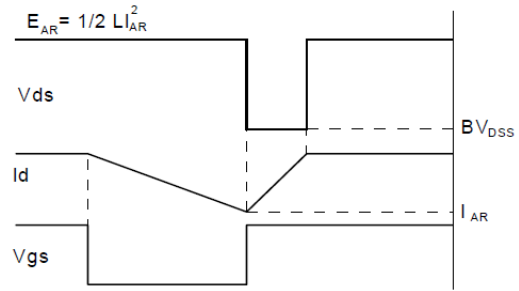
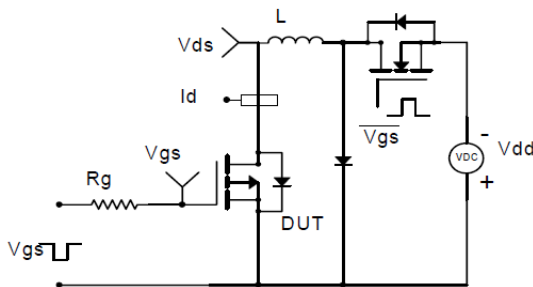

Diode Recovery Test Circuit & Waveforms

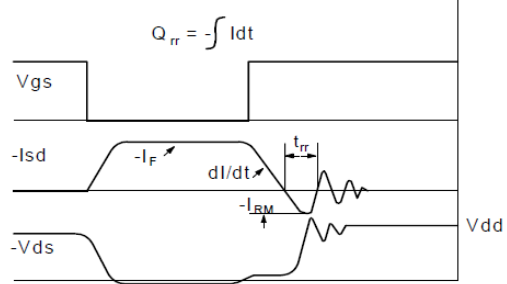
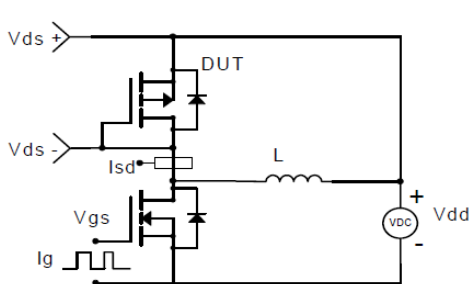

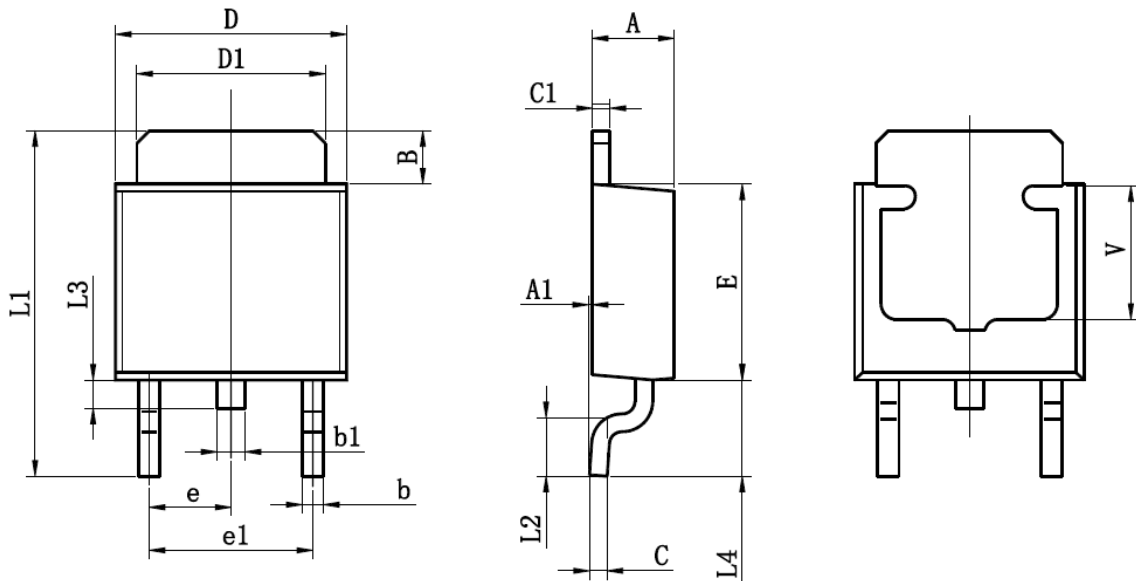
TO-252-2L PACKAGE OUTLINE

Symbol	Dimensions In Millimeters		Dimensions In Inches	
	Min	Max	Min	Max
A	2.200	2.400	0.087	0.094
A1	0.000	0.127	0.000	0.005
B	1.350	1.650	0.053	0.065
b	0.500	0.700	0.020	0.028
b1	0.700	0.900	0.028	0.035
c	0.430	0.580	0.017	0.023
c1	0.430	0.580	0.017	0.023
D	6.350	6.650	0.250	0.262
D1	5.200	5.400	0.205	0.213
E	5.400	5.700	0.213	0.224
e	2.300TYP		0.091TYP	
e1	4.500	4.700	0.177	0.185
L1	9.500	9.900	0.374	0.390
L2	1.400	1.780	0.055	0.070
L3	0.650	0.950	0.026	0.037
L4	2.550	2.900	0.100	0.114
V	3.80REF		0.150REF	